



## Dealer Ordering Guide

THE 2008 G-CLASS

G 500 • G 55 AMG

MODEL	BAUMUSTER	RELEASE DATE
G 500	463.249	AUGUST 2007
G 55 AMG	463.273	AUGUST 2007

### Model Year 2008 Highlights

- New Enhanced Instrument Cluster with Telephone, Radio & Navigation Sub-Menus
- New Coolant Temperature Gauge
- Redesigned Multi-Function Steering Wheel with Telephone & Radio Controls
- New Rear Taillight Design
- Standard Advanced Tire Pressure Monitoring System
- Standard Rear View Camera
- SIRIUS® Satellite Radio
- Standard Hands-Free Communication System
- Standard Tele Aid



Redesigned Multi-Function Steering Wheel with Telephone & Radio Controls



Added Coolant Temperature Gauge



New Rear Taillight Design



Standard Rear View Camera

## Vehicle Specifications / Technical Data

ENGINE	G 500	G 55 AMG
Configuration	5.0L V8	5.5L V8
Horsepower	292 hp @ 5,500 rpm	493 hp @ 6,100 rpm
Torque	336 lb-ft @ 2,800-4,000 rpm	516 lb-ft @ 2,650-4,000 rpm
Displacement	4,966 cc	5,439 cc
DRIVETRAIN		
Transmission Type	7-Speed Automatic Transmission	5-Speed Automatic Transmission
Drive Configuration	4WD	
STEERING		
Steering	Recirculating Ball with Power Assist and Hydraulic Damper	
Turning Radius	43.5 ft.	
WHEELS/TIRES		
Standard Wheel	18" 5-Spoke Wheels (7.5 x 18.0)	18" AMG Wheels (9.5 x 18.0)
Standard Tire	265/60 R18 All-Season	285/55 R18 High Performance <sup>1</sup>
DIMENSIONS		
Wheelbase	112.2 in.	
Length	185.6 in.	
Width	71.3 in.	
Height	77.8 in.	
Headroom front/rear	42.2 in./40.0 in.	
Legroom front/rear	52.5 in./41.9 in.	
Curb Weight	5,510 lbs.	5,635 lbs.
CAPACITY		
Towing Capacity	7,000 lbs.	
Fuel Tank	25.4 gallons	
Cargo Capacity (behind 1st row)	79.5 cu.ft. / 45.2 cu.ft.	
PERFORMANCE		
Acceleration (0-60 mph) <sup>2</sup>	7.4 sec.	5.4 sec.
Fuel Economy (City/Hwy) <sup>3</sup>	12 mpg/15 mpg	11 mpg/13 mpg

<sup>1</sup> Lower aspect ratio tires and accompanying wheels provide substantially increased treadwear, tire noise and reduced ride comfort. Serious wheel and tire damage may occur if the vehicle is operated on rough or damaged road surfaces or upon encountering road debris or obstacles. These tires are not designed for use on snow and ice. Winter tires mounted on appropriately sized and approved wheels are recommended for driving in those conditions. <sup>2</sup> Stated rates of acceleration are based upon manufacturer's track results and may vary depending upon model, environmental and road surface conditions, driving style, elevation and vehicle load. <sup>3</sup> Compare the estimated MPG to the estimated MPG of other vehicles. You may get different mileage depending on how fast you drive, weather conditions and trip length. Your actual highway mileage will probably be less than the highway estimate.



# MY08 G-Class

## Standard Equipment

### Comfort / Convenience:

- Power Tilt/Sliding Glass Sunroof
- DVD Navigation
- harman/kardon® Digital Sound System
- Bi-Xenon Headlamps with Corner-Illuminating Foglamps
- Rear Parking Assist
- Heated Front & Rear Seats
- Electrically Heated Windshield
- Heated Wood/Leather Steering Wheel
- Multicontour Driver's Seat
- *designo* Exclusive Leather Upholstery on Seats & Door Inserts with Cross-Stitching (G 55 AMG)
- AMG Exhaust System with Dual-Side Pipes on each side (G 55 AMG)
- Rear View Camera



Electrically Heated Windshield

### Safety / Security:

- Permanent 4-Wheel Drive
- Rugged "Ladder Frame" Chassis
- Tele Aid Emergency Calling and Communication System
- Pre-Tensioners and Force Limiters on Front & Rear Seat Belts
- Electronic Stability Program (ESP) with Brake Assist (BAS)
- 4-Wheel Electronic Traction Control (4-ETS) & Electronic Brake Force Distribution
- Driver and Passenger Front Air Bags with BabySmart™
- Window Curtain Air Bags for All Rows
- Rigid Axles with Longitudinal and Transverse Control Arms



Standard Rear View Camera

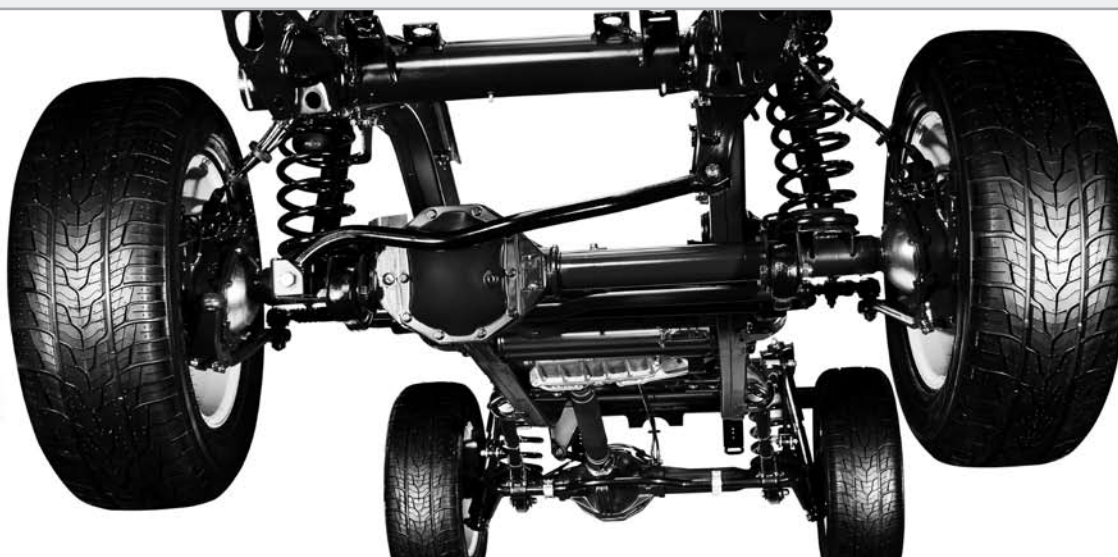

# G 500

MSRP: \$86,200<sup>4</sup>

## Specifications:

- 5.0L SOHC 24-valve V8
- 292 hp with 336 lb-ft torque
- 7-Speed Automatic Transmission
- 0-60 mph: TBD<sup>2</sup>
- 18" 5-Spoke Wheels
- 4-Wheel Drive



New Rear Taillight Design & Rear Park Assist



7-Speed Automatic Transmission



Premium Leather and Elegant Wood Trim Interior



Bi-Xenon Headlamps with Corner-Illuminating Foglamps

<sup>2</sup> Stated rates of acceleration are based upon manufacturer's track results and may vary depending upon model, environmental and road surface conditions, driving style, elevation and vehicle load. <sup>4</sup> MSRP excludes destination and delivery charge of \$775.



# G 55 AMG

MSRP: \$109,900<sup>4</sup>

## Specifications:

- 5.5L AMG SOHC 24-valve V8
- 493 hp with 516 lb-ft torque
- 5-Speed Automatic Transmission
- 0-60 mph: 5.4 seconds<sup>2</sup>
- 18" AMG Wheels
- 4-Wheel Drive



18" AMG Wheel, Painted Titanium Grey



5.5L AMG V8



AMG Exhaust System with Dual-Side Pipes



Standard Grille Guard with Turn Signal Cages

<sup>2</sup> Stated rates of acceleration are based upon manufacturer's track results and may vary depending upon model, environmental and road surface conditions, driving style, elevation and vehicle load. <sup>4</sup> MSRP excludes destination and delivery charge of \$775.



G 500	
UPHOLSTERY	
STANDARD	
Premium Leather	
MSRP	Standard
CODE	851
COLORS	Black
TRIM	
CODE	V56
STANDARD	Burl Walnut





BLACK UPHOLSTERY WITH BURL WALNUT



GREY UPHOLSTERY WITH BURL WALNUT

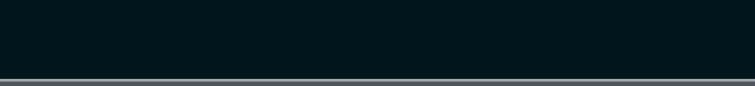

G 55 AMG					
UPHOLSTERY		STANDARD			
		Premium Leather			
MSRP	CODE	Standard			
		ZK0	ZF0	ZF2	ZF3
		Charcoal	Light Brown	Corteccia	Porcelain
TRIM					
CODE	STANDARD	ZM0+ZM9			
					
CODE	STANDARD	V56			
					

EXTERIOR	CODE	COLOR	AVAILABLE WITH ANY TRIM AND UPHOLSTERY
	040	Black	
	197	Obsidian Black*	
	368	Flint Grey*	
	650	Arctic White	
	723	Pewter*	
	775	Iridium Silver*	

\* Metallic paint



G 500



Electrically Heated Windshield

Aluminum Running Boards

Bi-Xenon Headlamps with Corner-Illuminating Foglamps

G 500



Rear View Camera

Spare Tire

Rear Park Assist

G 55 AMG



Chrome Grille Guard

Front Bumper Underbar

Front Turn Signal Cages



©2008 Mercedes-Benz USA, LLC • One Mercedes Drive, Montvale, NJ 07645 • 1-800-FOR-MERCEDES • MBUSA.com

Product Management. All illustrations and specifications contained in this Dealer Ordering Guide are based on the latest product information available at the time of publication. Mercedes-Benz reserves the right to make changes at any time, without notice, in colors, materials, equipment, specifications and models. Prices are manufacturer suggested retail prices and are subject to change up until vehicle launch date. Any variations in colors shown are due to reproduction variations in the printing process. Illustrations may include test situations. Some vehicles may be shown with non-U.S. equipment. Some vehicles are shown with optional equipment. Homelink® is a registered trademark of Prince, a Johnson Controls Company, harman/kardon® and LOGIC7® are registered trademarks of Harman International Industries, Inc. iPod is a registered trademark of Apple Computer, Inc.



Mercedes-Benz

Printed in U.S.A. August, 22 2007